



# Product Specification

## COB LED Flexible Strip

FLCOB-12432/24420-5/6mm

Made by	Checked by	Date	Product
Tony	Mike	2020.04.22	Led strip



## Company Profile:

Based in Shenzhen, PRC. Since 2009, Shenzhen Easing Home Opto-electronics Co Ltd is passionate about lighting and technology, and has rapidly grown to be a leading supplier for LED strip, LED profile, LED linear light, LED silicon neon flex and other relative accessories to clients for full range product & service. Currently we Easinghome LED has a professional lighting design team of engineers and a number of automated production lines.our products have been sold to more than 80 countries and areas. We are continuing to develop the new energy conservation and environment protection, high efficient product for you.



Shenzhen Easing Home Opto-Electronic .,Co Ltd.

- ADD 1: No 196, Tangtou Rd, Shiyao Street, Baoan District, Shenzhen, Guangdong, China
- ADD 2: Building No.3, 2nd Baoshi Road, 2nd Tianliao Industrial Area, Gongming Street, Guangming New District, Shenzhen City 518106, Guangdong Province, China

- www.easinghome.com    www.ledlits.com    www.ledhomex.com
- contact@easinghome.com
- 86-0755-27640099



**COB LED strip is designed for spots-free led linear lighting, suitable with any kinds of led profile and silicon tube.**



## Feature

1. dots-free with uniform lighting
2. Efficacy Lumen upto 120lm/watt
3. Cuttable and solderless connection with crystal connector



## Light Source

wire inside chips	99.99% purity golden (1.0um or above diament)
chip size	big size chip with high output lumen
phosphor powder	Mitsubishi or Intermatix phosphor powder
chip brand	Epistar or brand chip
LED lead frame	100% purity copper LED lead frame
PCB	35U cooper PCB/ double side PCB/ back side of PCB is protection layer
Bin code	one order, one small BIN Code only, and ledhome can promise you sereral orders from same one Bin
3M tape	300P genuine 3M tape /3M VHB tape
age testing	ledhome strip take at least 8hours aging-test
QC Checking	3 times QC checking(SMT + PCB jointing+ after aging testing) before packing

## Technical Drawing

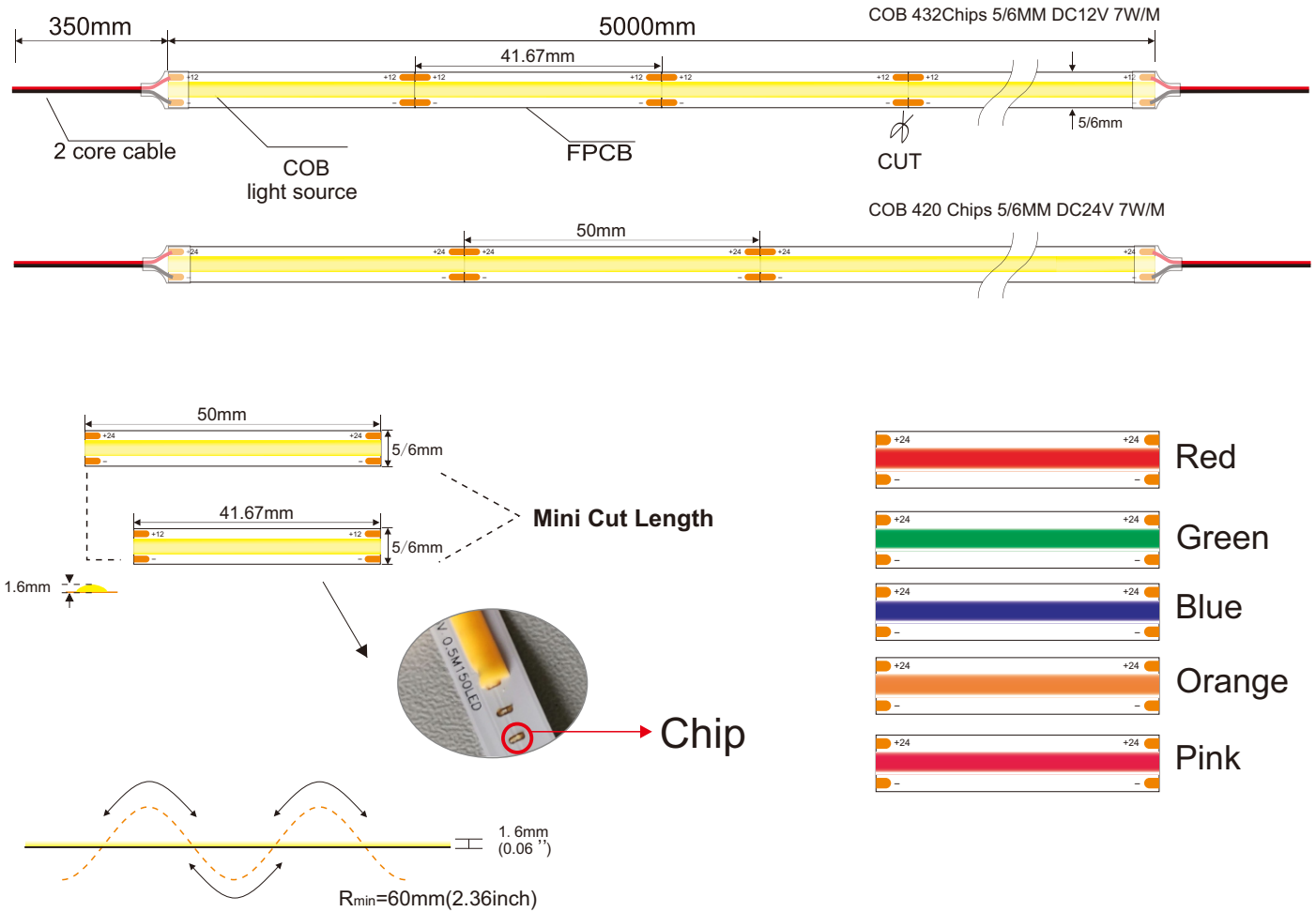

## Basic Parameter

Number	Voltage	Power W/m	Color	Lumen CRI>80	Lumen CRI>90
FLCOB-12432	12V	7W	3000K	621LM	573LM
			4000K	656LM	620LM
			6000K	680LM	628LM
FLCOB-24420	24V	7W	3000K	678LM	602LM
			4000K	710LM	674LM
			6000K	714LM	688LM

Note: All above parameters were given based on naked strip without additional heat sink or housing. Customized size or customized color temperature, pls contact us further.

## Product Parameters

### Spectroscopic standard

Ensure customers to get the same bin for different orders by using CIE(X,Y) coordinate spectrometer

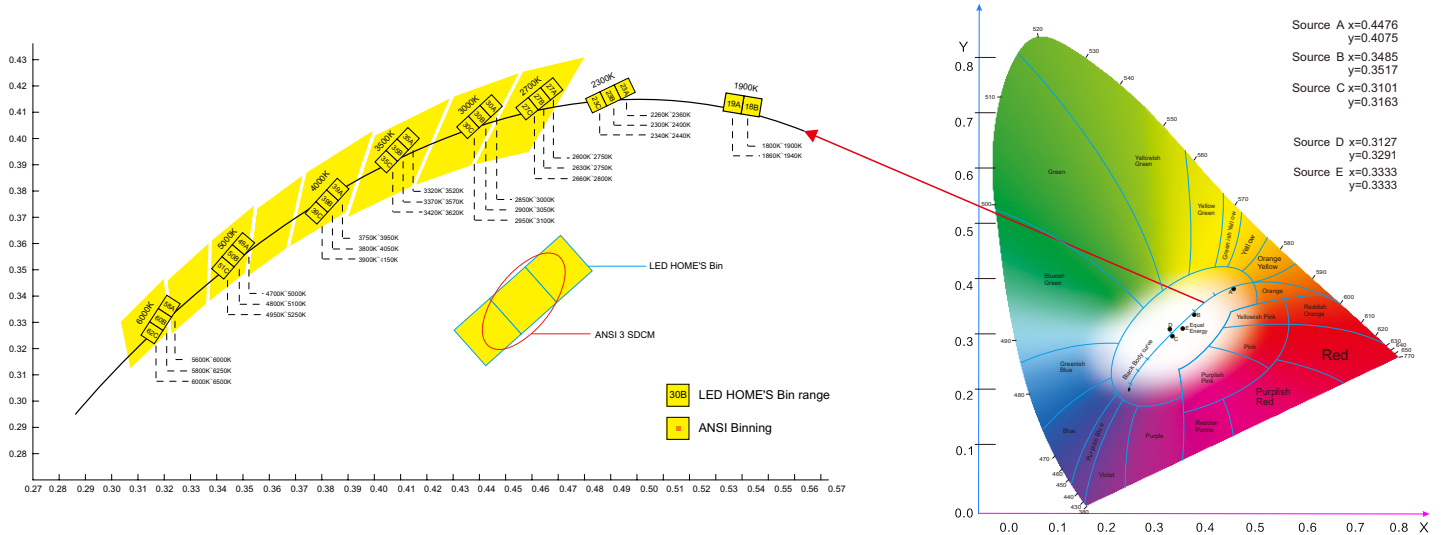

## Product Specification

Item:	COB led strip	Driver:	External led driver
Qty Chips:	432chips/m 420chips/m	Mains voltage (V):	DC 12/24V
Color:	White/Red/Green/Blue	Control gear type:	CONSTANT VOLTAGE DRIVER
PCB width:	5/6mm	Ref:	MEANWELL
Light controller type:	0-10V/1-10V/DMX/DALI/Triac	Emergency availability:	/
Light Decay:	2% @ 6000Hours	Chip:	Epistar or other brand chips
Operating Temperature:	-25~45 degree	Light emission:	180°
Lifetime:	(Lm80) 50000 HRS @45degree	Deviation (SDCM):	3step MacAdam ellipse
Mounting:	3M adhesive tape	BIN:	ONE BIN Only
Max running length:	10meter (two side feed)	Warranty:	3 years
Luminaire in:	CLASS II/III		

## Light Distribution Curve [Unit:cd]

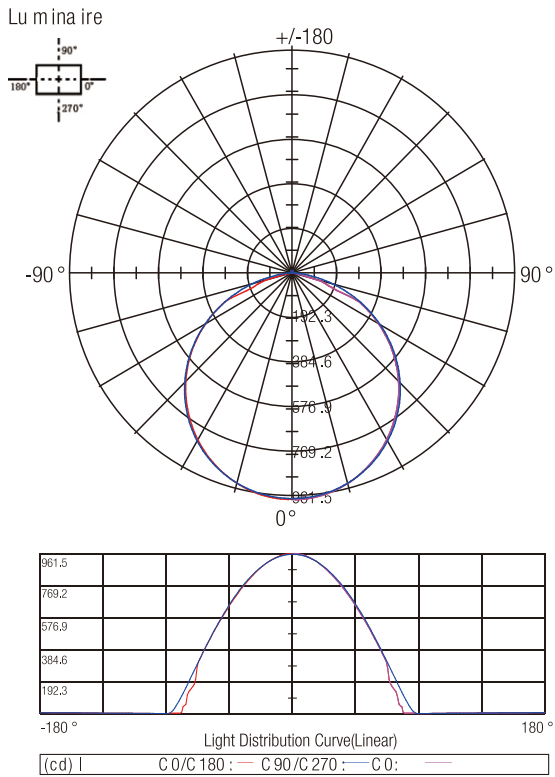

## Lux-Distance Curve

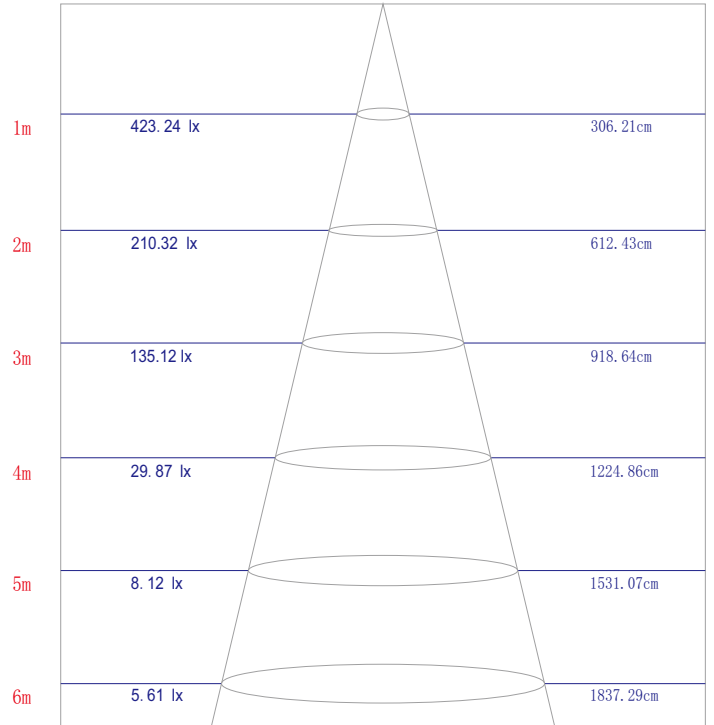

Height E Diameter  
Beam Angle: 113.60°

## Colour Rendering Index

R1	R2	R3	R4	R5	R6	R7	R8	R9	R10	R11	R12	R13	R14	R15
92	94	95	91	90	91	95	86	64	85	91	65	92	97	89

## LED Strip Solution

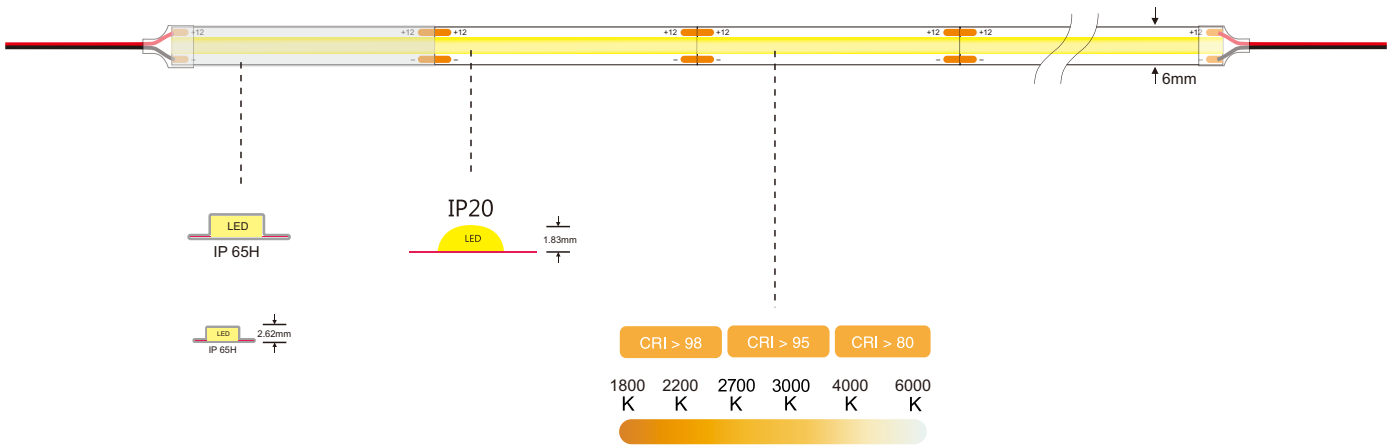

### One end feed

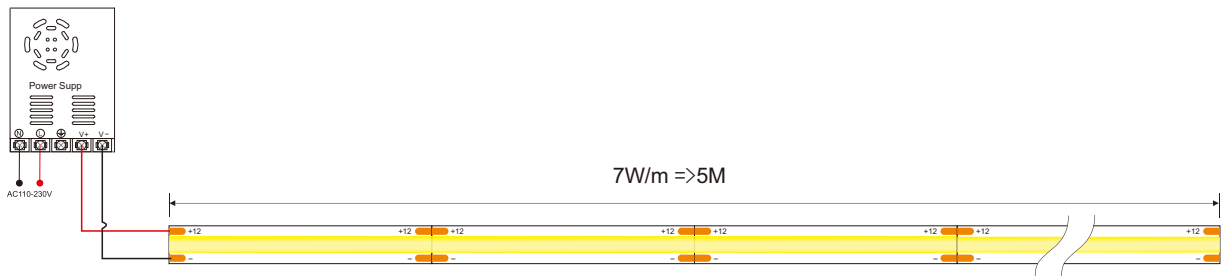

### Two ends feed

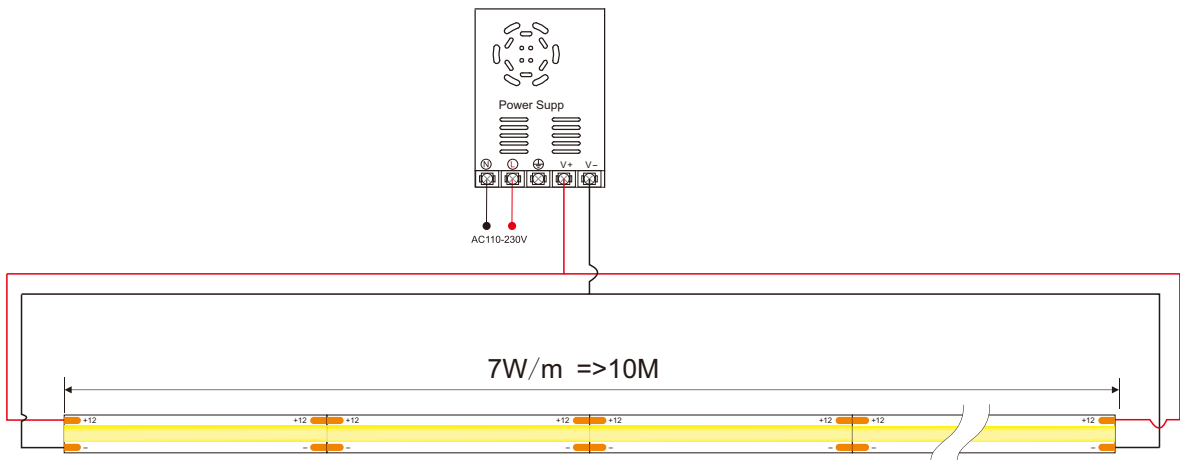

## IP Level Diagram

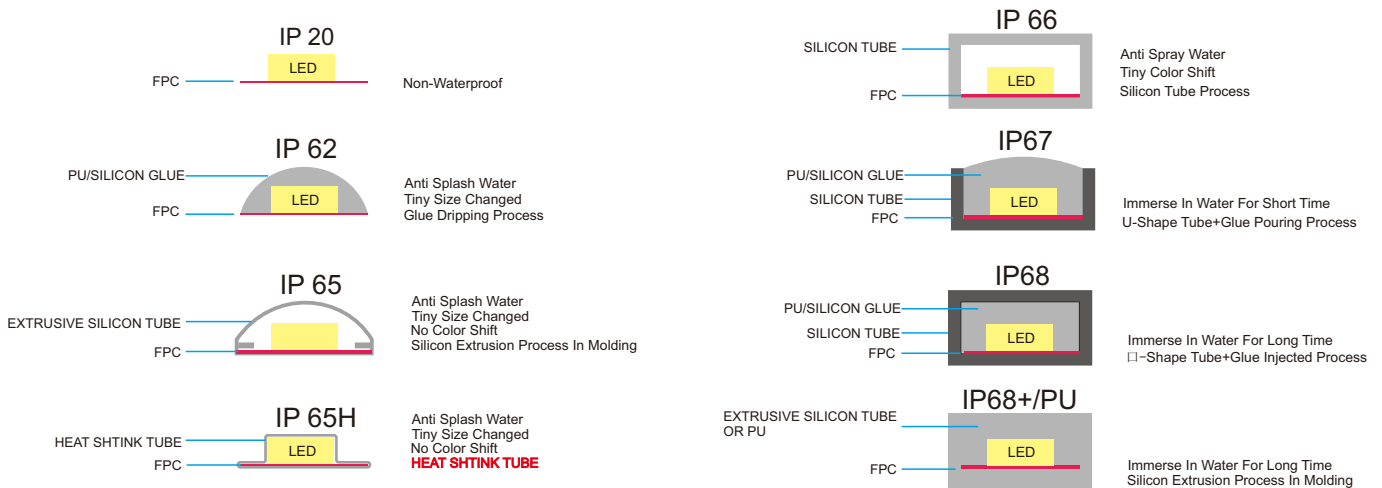



## Installation Diagram:

### 1. Regular connection



### 2. connection with dimmer

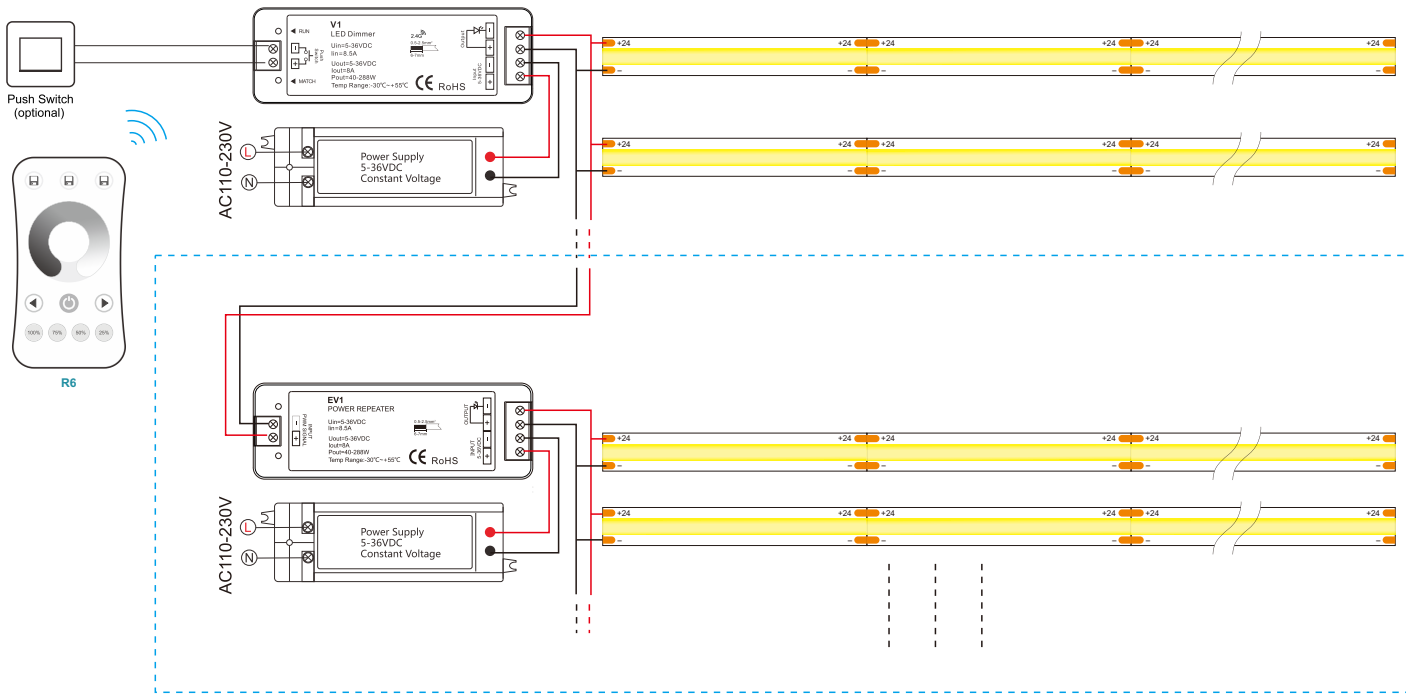

### 3. DMX Connection

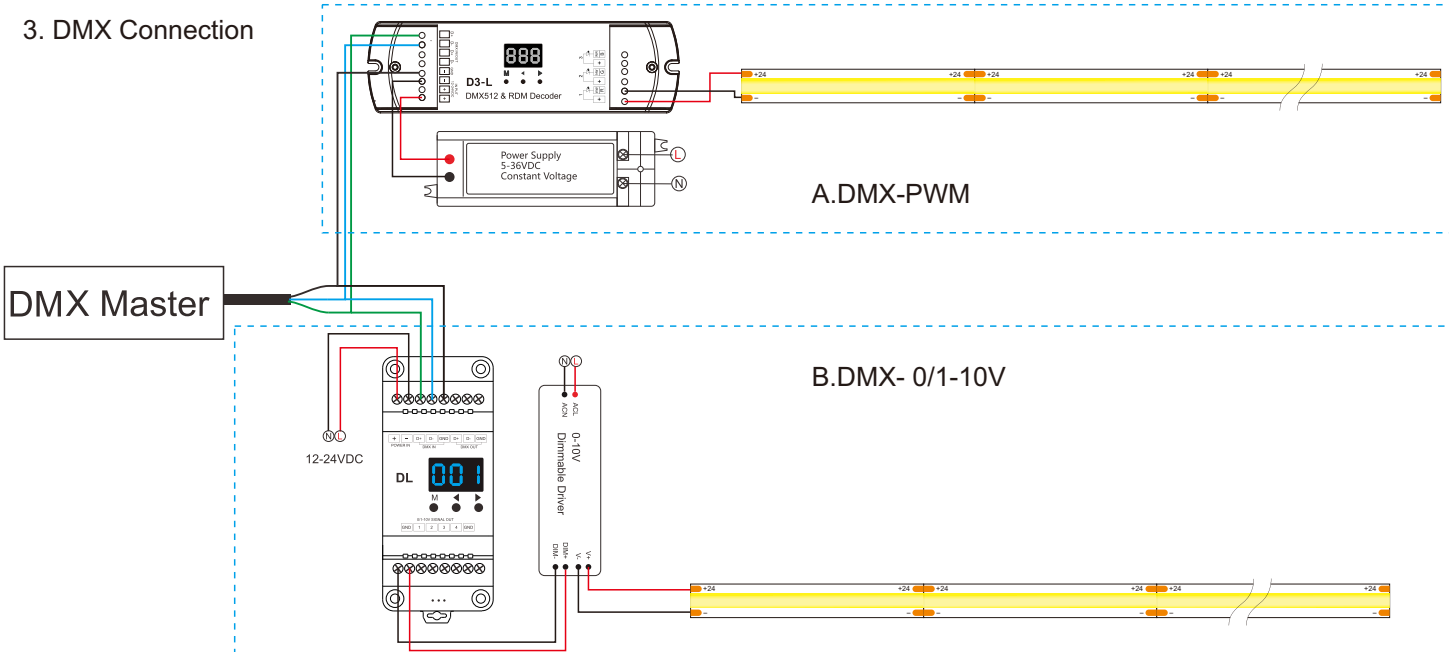

## Installation

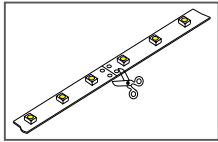

1. Cut in specific location

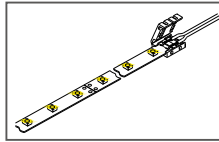

2. Put the PCB in the space between clip and connector, make the clips exactly aim at welding point

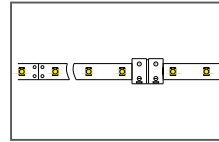

3. Close the cover of connector

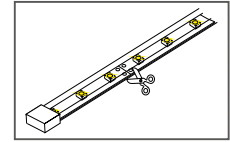

1. Cut in specific location

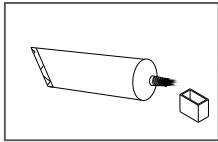

2. Infuse the gel in the end cap

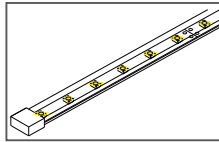

3. connect the end cap and wait for air drying

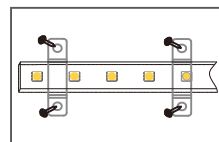

1. Install with clips

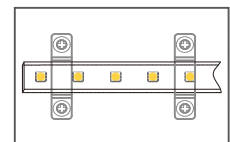

2. Fix with screws

### 1. STRIP TO STRIP INSTALLATIONS

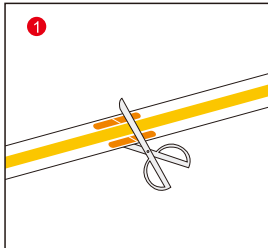

1. Cut the light strip from the cut point

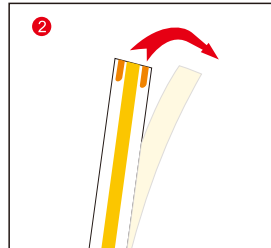

2. Tear or the 3M glue behind the light strip

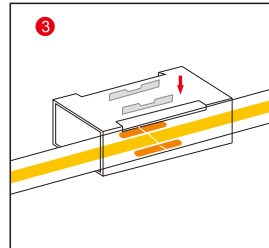

3. Put the COB light strip inside the crystal connector and press the iron piece down.

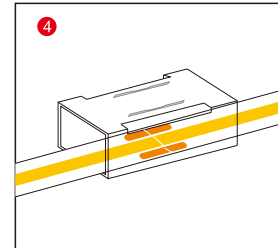

4. Test the light strip after pressing down the iron sheet, the installation is complete

### 2. STRIP TO WIRE INSTALLATIONS

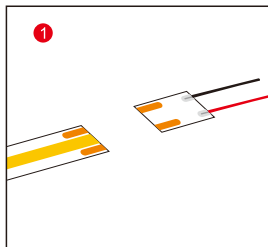

1. Prepare the dedicated cable for the crystal connector

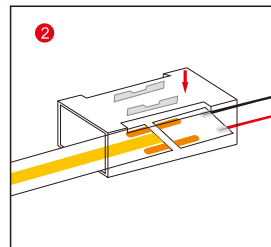

2. Put the light strip and cable into the crystal connector and press down the iron piece

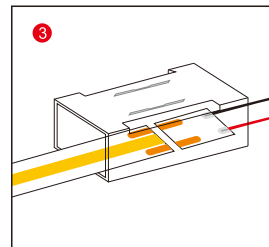

3. Installation is complete, test the light strip

## Accessories:

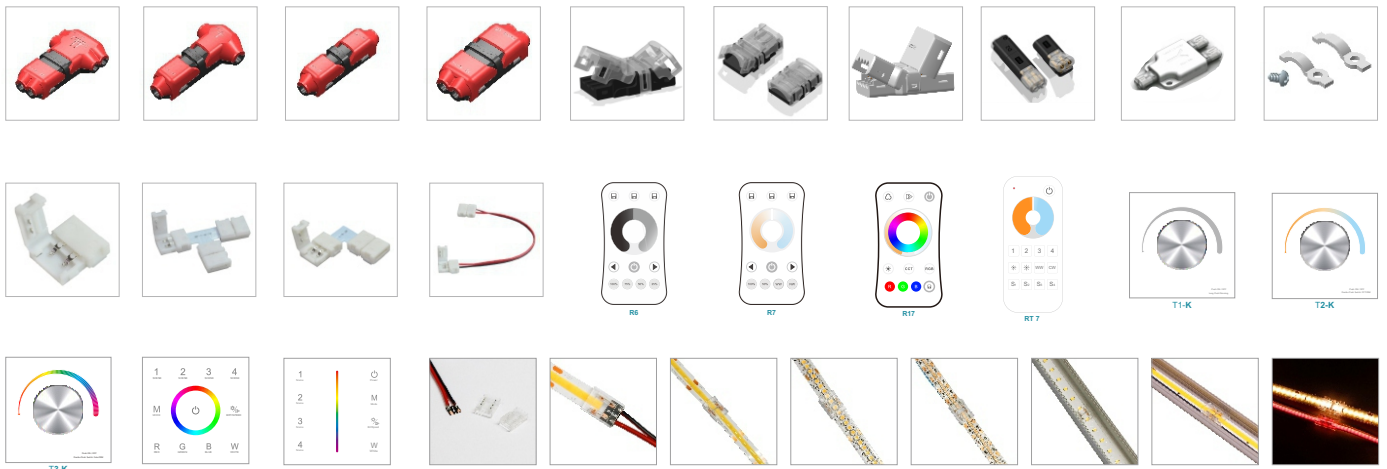

## Cautions



When install the led strip, please note the installation technique. The led strip can be bent, but not distorted, as shown below.

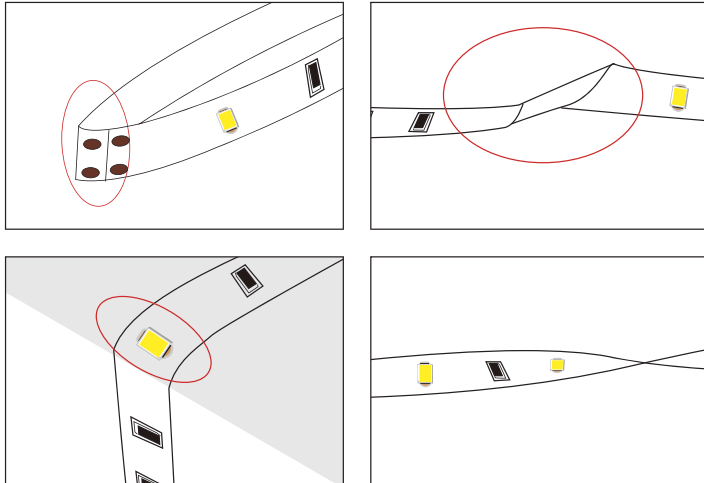

Distortion (Wrong)

LED strips are low voltage products, you must use the power supply (transformer). Please don't connect the led strip directly to the AC 110v or AC 220v, otherwise it will burn out the LED strips.

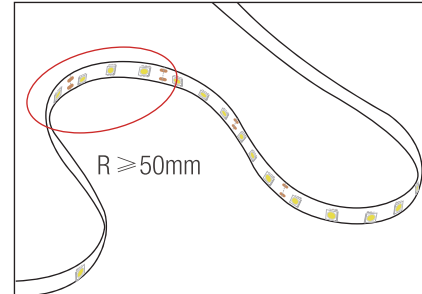

Bend (Right)

Clean up the installation surface, it will ensure the reliability of the adhesive. The electrical connection process must be operated by a professional person.

## Packing:

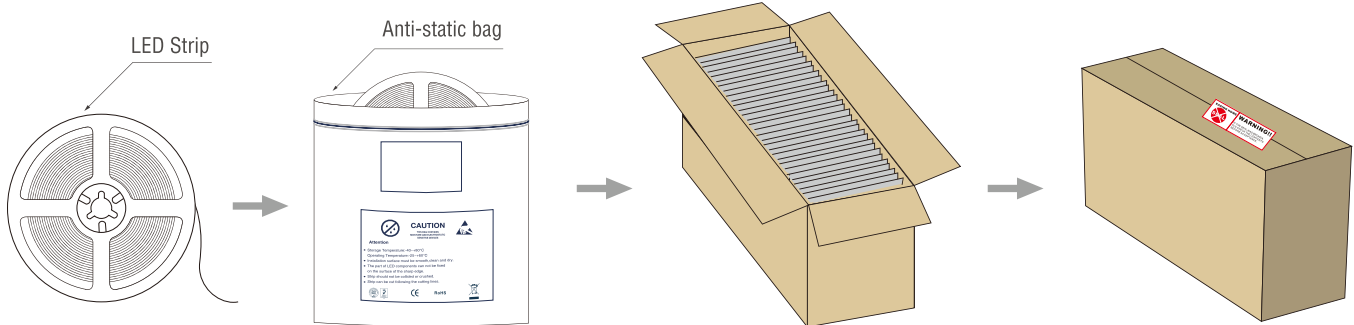

## Notice:

- 1、 Please apply different IP rate products according to different environment conditions;
- 2、 Adopt suitable power supply to match the LED strips. Power is 20% bigger than max power of LED strips to ensure long time performance of power supply;
- 3、 Do not install it when power is on. Before powering on, please make sure the wiring is correct;
- 4、 Avoid privately changing or damaging the circuit or other component on the strip;
- 5、 Avoid scrape or bending during installation, it might be damaged with non repairable status;
- 6、 Strip linked in over long length would lead to problem of overload or uneven brightness;
- 7、 To protect your eyes, do not stare at the light for a long time while it's illuminated;
- 8、 Only professional personnel can install, dismantle and repair;
- 9、 Choose different connectors and controllers according to your different strip.